



SmartWAMS™

◆ ◆
Smart Wide-Area Monitoring System

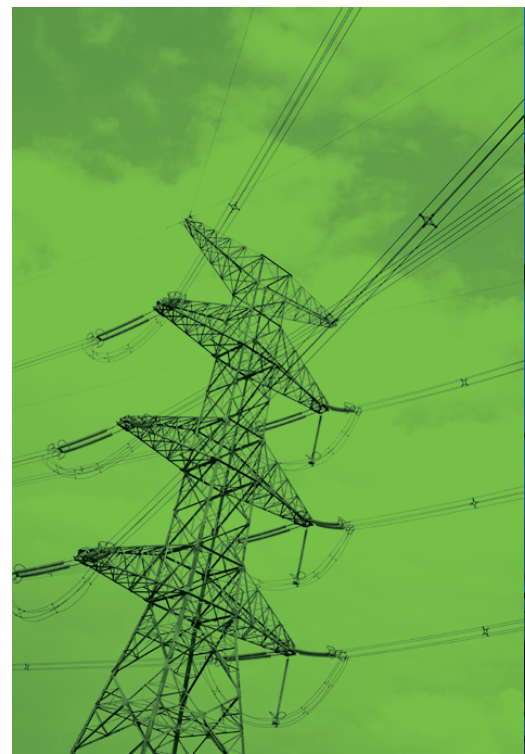

Table of Content

A. Product Overview.....	4
1. ADVANTAGES	4
2. REAL TIME APPLICATIONS.....	4
3. OFF-LINE APPLICATIONS	4
B. Technical Highlights	5
1. OVERALL ARCHITECTURE	5
2. MAIN COMPONENTS	6
2.1. GPS Clock.....	6
2.2. Phasor Measurement Unit (PMU)	6
2.3. Phasor Data Concentrator (PDC)	6
2.4. Communication.....	6
2.5. Storage/History	7
2.6. Application/HMI	7
3. MAIN DISPLAY BLOCKS AND ALERTS	7
4. HUMAN-MACHINE INTERFACE (HMI)	8
4.1. Dashboard	8
4.2. Voltage.....	9
4.3. Frequency.....	9
4.4. Power Flow.....	10
4.5. Voltage Sensitivity	10
4.6. Angle Sensitivity	11
4.7. Alarm	11



A. Product Overview

SmartWAMS™ (Smart Wide Area Monitoring System) is a system for gathering, processing and displaying synchrophasor data based on Phasor Measurement Unit (PMU). This system allows for wide monitoring of power system with high reliability and fast data update time.

SmartWAMS™ system is designed to comply with world standards (eg. IEEE, IEC) and is compatible with all requirements for operating power system in Vietnam. The system can be used independently with SCADA/EMS system and simultaneously supports SCADA/EMS systems for real-time/on-line monitoring and operation as well as calculation and post-operation analysis of power system.

REAL TIME APPLICATIONS

- ◆ Enhance system situational awareness by displaying and alerting with real-time data of the system operation status:
 - * Frequency (f) and rate of change of frequency (df/dt);
 - * Voltage & current (Magnitude & Angle);
 - * Angle difference ($\Delta\delta$);
 - * Power flow (MW, MVA);
 - * Voltage & angle sensitivities (dV/dP, dV/dQ, d δ /dP)
- ◆ Increase observability, speed, and improve accuracy of state estimation (SE). The SE model can use PMU data or by combining PMU and SCADA data..
- ◆ Calculate stability margin (steady state & voltage stabilities, etc.) and alert:
- ◆ Load capacity of the grid based on phase angle difference;
- ◆ Frequency stability based on frequency observation in different areas;
- ◆ System stability based on rate of change of the parameters (voltage, frequency);
- ◆ Voltage stability based on voltage magnitude and reactive power reserve;
- ◆ System stability based on sensitivities (dV/dQ)
- ◆ Provide data for optimal power flow calculation (OPF), voltage and reactive power regulation
- ◆ Calculate power transmission limit and capacity of transmission lines with third-party softwares such as PSS/E, DigSILENT, Quick-Stab, etc.
- ◆ Detect and localize events occurred on the grid which may have significant impact on operation of power system
- ◆ Early detection of power fluctuations on power system.

ADVANTAGES

- ◆ Connection & collection of SynchroPhasor Data in real time with a sampling cycle of up to 30 samples per second
- ◆ Process and display of the Wide Area Data of power system such as: f, U, δ , P, Q, etc.
- ◆ Big data archived and stored in multiple databases such as PI, SQL, Oracle, etc.
- ◆ Interact with application systems such as SCADA/EMS, PSS E software, DigSILENT, etc.
- ◆ Support standard connection protocols such as: IEEE C37.118, IEEE 1344-1995, Gateway Stream, SEL Fast Messaging, etc.
- ◆ Support standard communication protocols such as TCP (IPv4 and IPv6), UDP (IPv4 and IPv6), Serial

OFF-LINE APPLICATIONS

Off-line applications are based on Historian Information System (SmartHIS™) database and able to:

- ◆ Analyze incident/event occurring on power system in conjunction with the existing SCADA/EMS
- ◆ Provide parameters to simulate power system condition before, during, and after the incident on third-party simulation programs such as PSS/E, DigSILENT, etc.
- ◆ Adjust the parameters of power system (transmission lines, transformers)
- ◆ Review and re-evaluate the power, voltage, current and phase angle (P/Q/U/I/delta) of power system after wide-area faults
- ◆ Help to create sequence of event (SOE) for analyzing wide area problems; locate and identify fault events on grid
- ◆ Evaluate demand response and construct load model based on SynchoPhasor data stored in the HIS system of WAMS
- ◆ Provide monitoring and reporting of information via Web technology to multiple users. The modules may include: Monitoring, Reporting, e-Notification, e-Alarm.
- ◆ SmartHIS™ provides operational data to evaluate and correct dynamic models of generator sets, as well as data for evaluation of post-operation.

1. OVERALL ARCHITECTURE

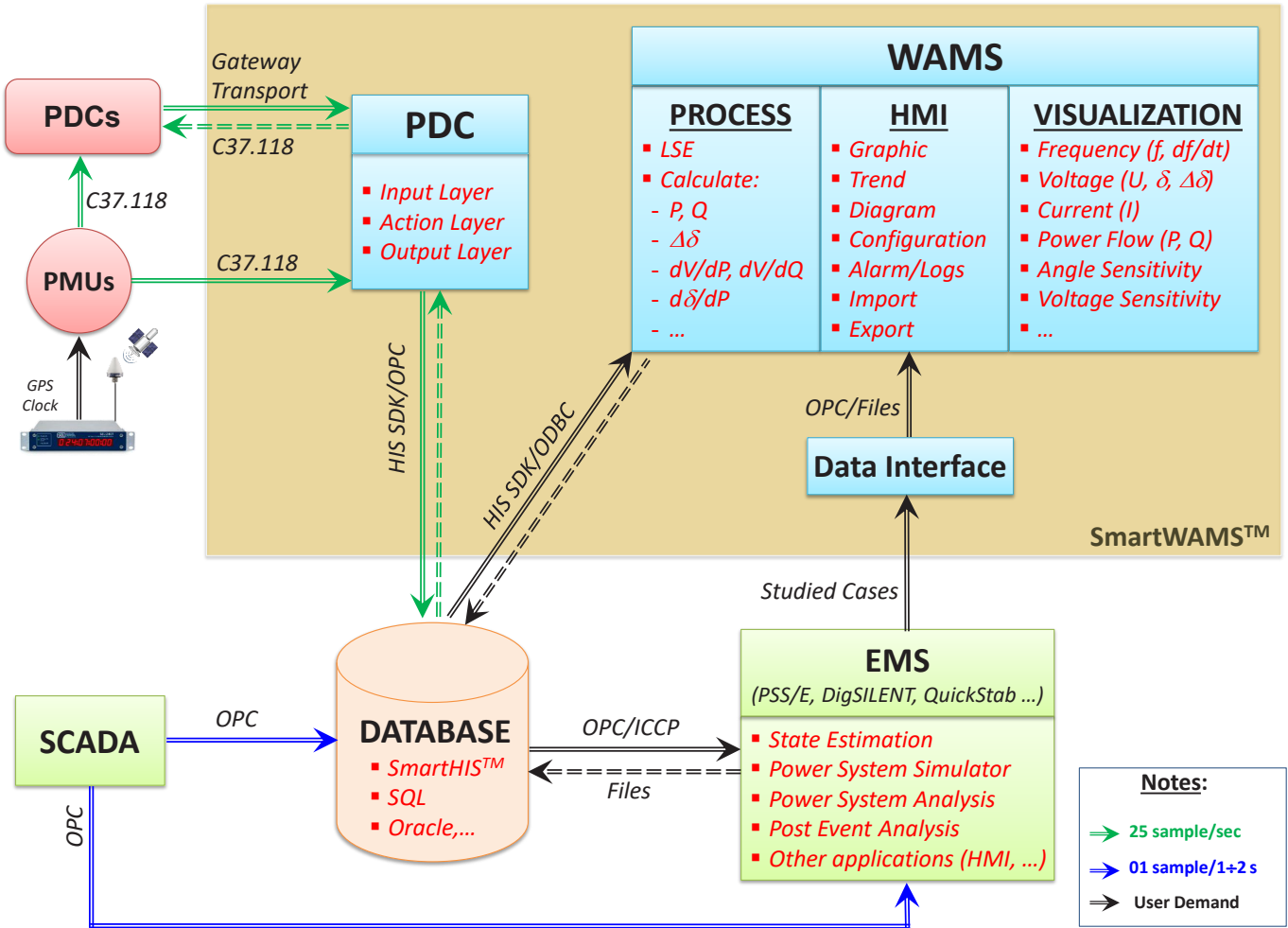

Figure 1. Overall Architecture and Data Flow of SmartWAMS™

SmartWAMS™ and Synchrophasor technology is NOT a replacement for SCADA. Rather, it's likely to be a complement for the existing SCADA systems.

Attribute	Synchrophasor (PMU)	SCADA/EMS
Data periodicity	10 ÷ 60 samples per second	1 sample every 2 ÷ 4 seconds
Angle measurement	Yes	Not possible
Time synchronization	Possible	Not possible
The system dynamic behavior monitoring	Possible	Not possible
Oscillation monitoring	Possible	Not possible
Focus	Wide area monitoring	Local monitoring
Total Input/Output Channels	~10 (Phasors); 16+ (Digital); 16+ (Analog)	100+ (Analog & Digital)

Table 1. Synchrophasor vs. SCADA Measurements

B. Technical Highlights

2. MAIN COMPONENTS

2.1. GPS Clock

GPS Clock uses Global Positioning System (GPS) to synchronize data over time with high accuracy. This is to synchronize all time-measured data from PMU in a substation and between substations on power system. All data and events at substations are stamped with a common time-line, thus enabling the monitoring, collection and analysis of incidents.

In addition, GPS Clock can synchronize time with computer, recording system, PBX system, etc. to ensure that the operating time of the grid, of the operation action and of data storage is completely consistent and accurate.

GPS Clock allows for time synchronization with accuracy up to nano second (for SEL-2401, SEL-2404, and SEL-2407, the accuracy range can reach within ± 100 ns).

2.2. Phasor Measurement Unit (PMU)

PMU is a basic device for measurement and can be integrated in protection relays and digital fault recorders (DFR) at substations and power plants with phasor capabilities.

PMU has the following basic characteristics:

- ◆ The input of PMU is the incoming signals from the current transformer and the voltage transformer located at the substations and transmission lines
- ◆ Measurement of frequency, magnitude and angle of current and voltage, etc. follows standard protocol (such as IEEE 1344, IEEE C37.118)
- ◆ The measurement data taken are precisely time-synchronized by GPS clock
- ◆ The data periodicity is about 30- 120 samples per second.

Most digital relays now incorporate phasor function as a PMU, such as in SEL relays (SEL-411L, SEL-421, SEL-451, etc.) with sample rate up to 60 samples/second.

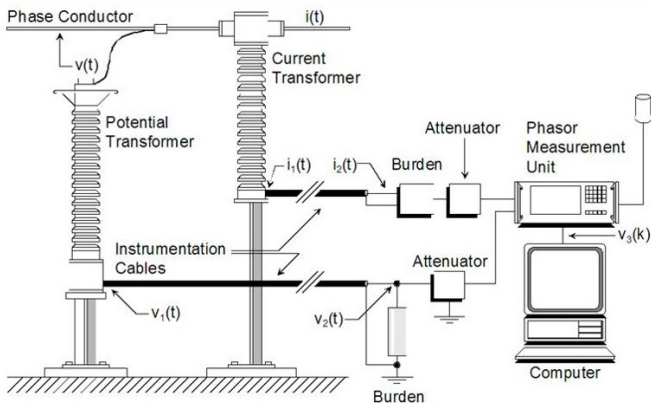

Figure 2. PMU Installation at Substations and Power Plants

2.3. Phasor Data Concentrator (PDC)

PDC is a software/hardware solution with following capabilities:

- ◆ Receive and time-synchronize phasor data from multiple PMUs
- ◆ Align the data and forwards it to various client applications and storages
- ◆ Can exchange two-way data with other PDC at other locations and with database systems such as PI, SQL, CSV, etc.
- ◆ Support most standard protocols (such as IEEE 1344, IEEE C37.118) and common protocols (such as 61850-90-5, SEL Fast Messaging, Gateway Transport; ODBC, etc.)

PDC kit includes both software and hardware solutions, such as SEL-3373.

2.4. Communication

Data exchange between PMU and PDC, among PDCs as well as other components of the SmartWAMS™ (including user applications) are facilitated .

The widespread communication network in SmartWAMS™ system is the Wide Area Network (WAN) or other data transmission systems that meet the requirements of a WAMS system such as: data synchronization, availability and security.

PMU and PDC is usually connected via modem/serial or LAN/Ethernet (with standard TCP/IP and UDP protocols). Connection between PDC to PDC as well as to other applications can be implemented with Internet, VPN, Intranet, GPRS/3G, etc.

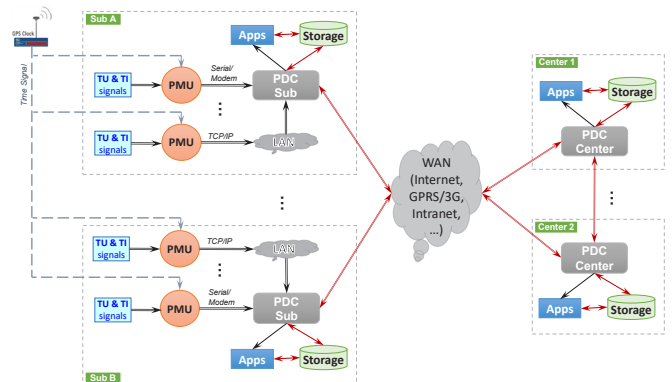

Figure 3. Illustration of Communication Model

2.5. Storage/History

SmartWAMS™ is equipped with database and data interface for storage purpose:

- ◆ **DataBase:** includes dedicated database system for storing and managing measurement data from PMU and SCADA through conversion protocols such as OPC, ICCP, PI SDK, or data file format.
- ◆ **Data Interface:** the interface between SmartWAMS™ and application software such as PSS/E, DigSILENT, QuickStab, etc. is mainly through file types (eg. Excel, xml, etc.)
- ◆ In addition, SmartWAMS™ can exchange and coordinate with SCADA systems through database and software applications.

2.6. Application/HMI

WAMS is the main component of the SmartWAMS™ system, which aggregates all data from different sources, then processes and displays them according to the user's purpose (Figure 4):

- ◆ **Process:** processes all of time-synchronizes phasor data measured from PMU before displaying. Processes include: linear state estimation (LSE), power flow calculations, phase angle difference, voltage and phase angles sensitivity calculation, etc.
- ◆ **Human - Machine Interface (HMI):** includes main functions for display and control on-screen such as Graphic, Diagram, Trend, Alarm, Logs, Configure, Import/Export.

3. MAIN DISPLAY BLOCKS AND ALERTS

Main display blocks of SmartWAMS™ are classified into four main groups:

- ◆ Display group of frequency (f) and rate of change frequency (df/dt);
- ◆ Display group of voltage magnitude (U), voltage angle (δ) and voltage angle difference ($\Delta\delta$);
- ◆ Display group of voltage & angle sensitivities (dV/dP , dV/dQ , $d\delta/dP$);
- ◆ Display group of power flow (MW, MVA).

User can observe the state of power system in various ways (in numerical or graphical form). These groups will be arranged according to the appropriate interface for users during usage.

With each state parameter in each display block, there are associated warning levels (corresponding to the prescribed limits) so that operators can easily recognize the status of power system.

There are three major status levels (Figure 5):

- ◆ Level 1: Normal status (Green)
- ◆ Level 2: Near-Critical status (Yellow)
- ◆ Level 3: Danger status (Red)

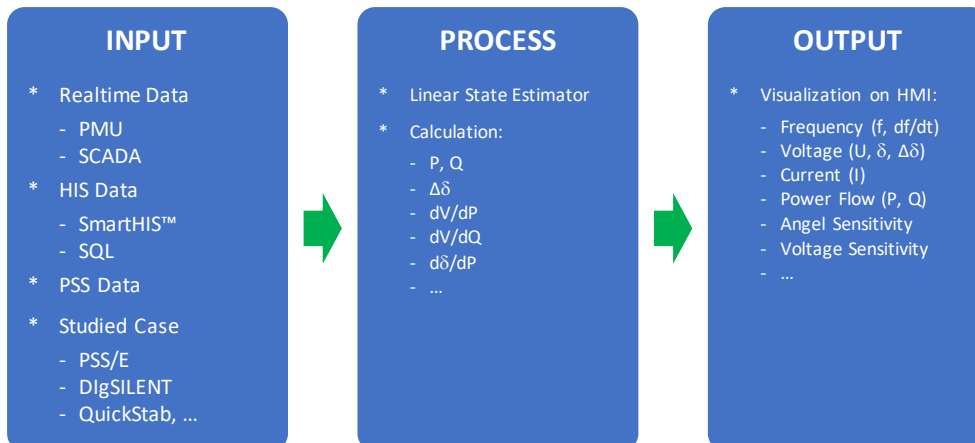

Figure 4. Data Exchange on WAMS

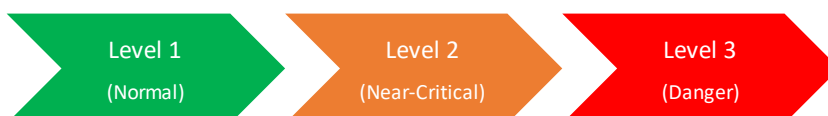

Figure 5. System Warning Color Rules

B. Technical Highlights

4. HUMAN-MACHINE INTERFACE (HMI)

HMI include following Tabs on screen:

- ◆ Dashboard: Main monitoring screen
- ◆ Voltage: Monitor parameters related to voltage
- ◆ Frequency: Monitor parameters related to frequency
- ◆ Power Flow: Monitor parameters related to power flow
- ◆ Sensitivity: Monitor parameters related to sensitivity
- ◆ Other related tabs: Including Alarm, Logs, Configure, Help, etc.

4.1. Dashboard

On Dashboard screen, operators can observe:

- ◆ The performance of the entire electrical system through grid diagram, with two ways of display:
 - * According to geographical map (Principle Diagram)
 - * According to single-line diagram (Single Diagram)
- ◆ Trend and frequency values of system at required observation nodes

- ◆ All warnings for each parameter of power system:
 - * (F): Warning on frequency
 - * (AD): Warnings of phase angle difference between two nodes
 - * (VM): Warnings of voltage magnitude
 - * (P): Warnings of active power (MW)
 - * (Q): Warnings of reactive power (MVAR)
 - * (VS): Warnings of voltage sensitivity (dV/dP, dV/dQ)
 - * (AS): Warnings of voltage angle sensitivity (Dd)
- ◆ Detailed graphs of each operating parameter on power system at each observation nodes.

Each diagram allows for simultaneous monitoring of important operating parameters on power system such as frequency, voltage, power flow, phase angle difference, voltage sensitivity and phase angle, etc. Users also can perform operations such as Zoom, Pan, stop the graph right at the time of observation or view past data.

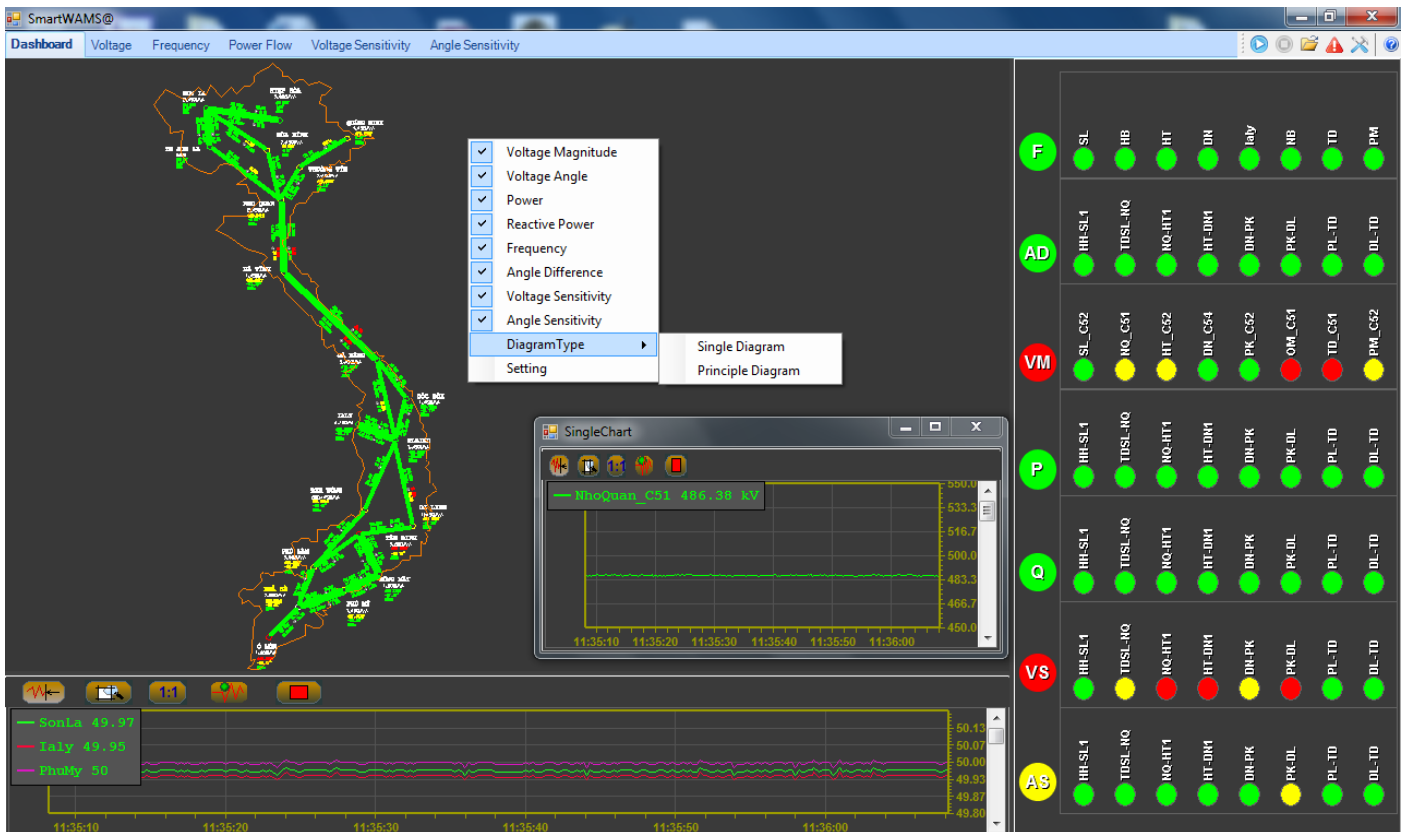

Figure 6. Dashboard Screen

4.2. Voltage

On Voltage screen, operators can observe (Figure 7):

- ◆ Operating parameters of the entire power system through the grid diagram, same as on Dashboard screen;
- ◆ Graphs of voltage magnitude and phase angle at one or more observation nodes;
- ◆ Graphs showing voltage phase angle difference between the observation nodes;
- ◆ Voltage warning levels for magnitude, phase angle and phase angle difference according to specified color.

The selection of viewpoints will be through the Check Option section right on the application. The operation on the Voltage screen is the same as on the Dashboard screen.

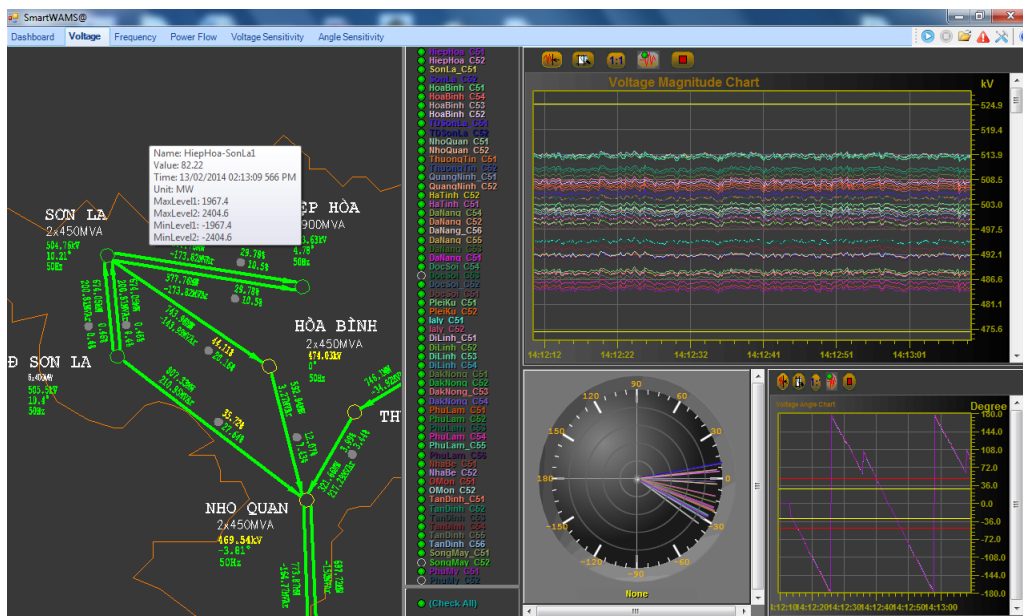

Figure 7. Voltage Screen

4.3. Frequency

On Frequency screen, operators can observe (Figure 8):

- ◆ Operating parameters of the entire power system through the grid diagram, same as on Dashboard screen;
- ◆ Graph of frequency (f) rate of change frequency (df/dt) at one or more observation nodes;
- ◆ Frequency warning levels according to specified color.

The selection of viewpoints will be through the Check Option section right on the application. The operation on the Frequency screen is the same as on the Dashboard screen.

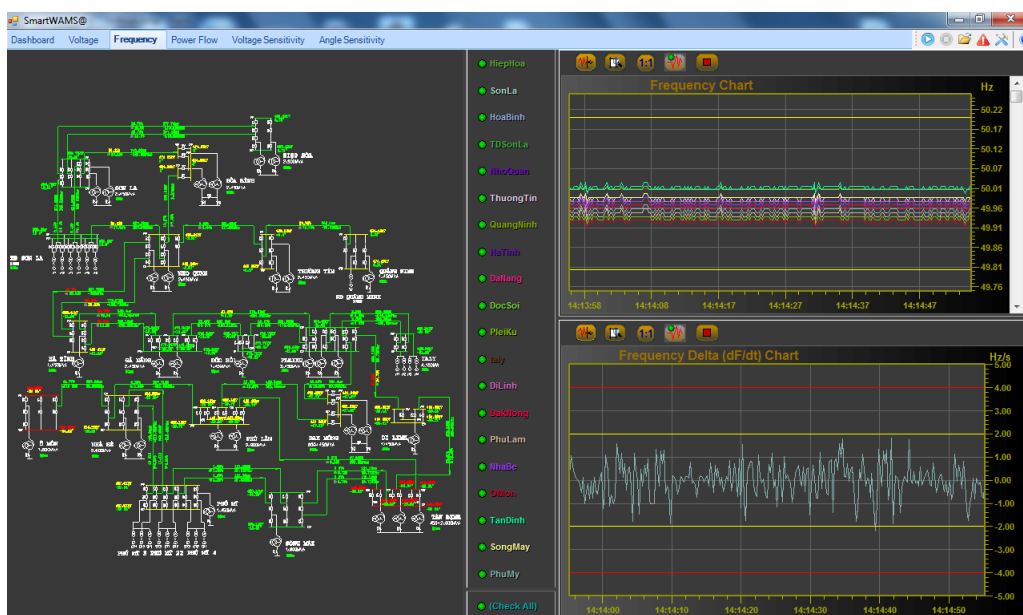

Figure 8. Frequency Screen

B. Technical Highlights

4.4. Power Flow

On Power Flow screen, operators can observe (Figure 9):

- ◆ Operating parameters of the entire power system through grid diagram, similarly to Dashboard screen;
- ◆ Graph of active power (MW) and reactive power (MVar) on the observation transmission lines;
- ◆ Power Flow warning levels according to specified color.

The selection of observation lines will be through the Check Option section right on the application. The operation on the Power Flow screen is the same as on Dashboard screen.

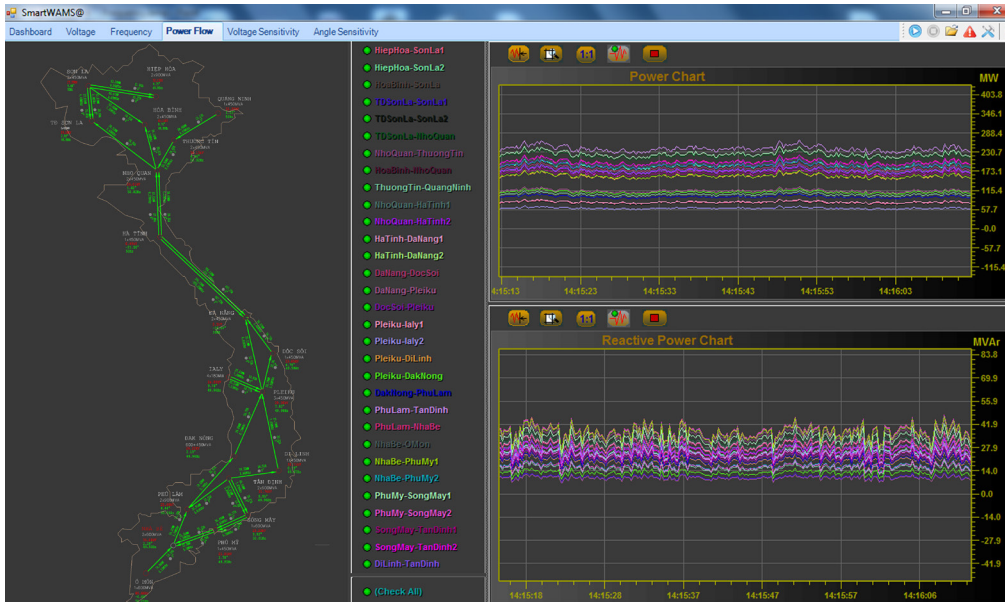

Figure 9. Power Flow Screen

4.5. Voltage Sensitivity

On Voltage Sensitivity screen, operators can observe (Figure 10):

- ◆ Operating parameters of the entire power system through grid diagram, same as on Dashboard screen;
- ◆ Rate of change voltage according to power flow (P, Q) on the transmission line through the P-V and Q-V characteristics;
- ◆ Voltage stability limits at the nodes
- ◆ When nearby transmission lines or elements are faulty;
- ◆ Voltage stability warning levels according to specified color.

The selection of observation lines will be through the Check Option section right on the application. The operation on the Voltage Sensitivity screen is the same as on Dashboard screen.

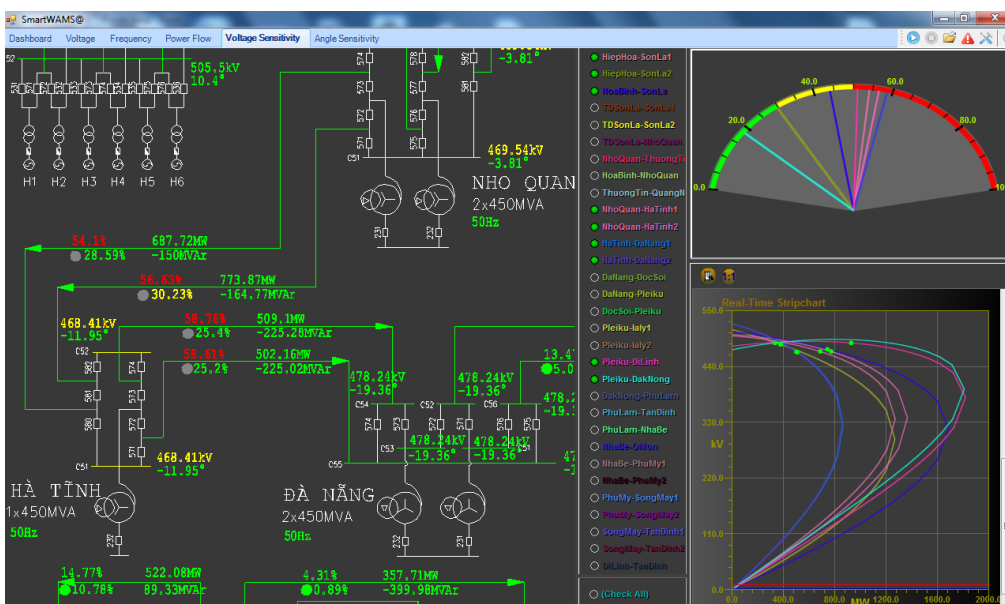

Figure 10. Voltage Sensitivity Screen

4.6. Angle Sensitivity

On Angle Sensitivity screen, operators can observe (Figure 11):

- ◆ Operating parameters of the entire power system through grid diagram, same as on Dashboard screen;
- ◆ Rate of change in voltage angle according to power flow according to P-d characteristics;
- ◆ Static stability limit and static stability reserve
- ◆ When nearby transmission lines or elements are faulty;
- ◆ Voltage angle stability warning levels according to specified color.

The selection of observation lines will be through the Check Option section right on the application. The operation on the Angle Sensitivity screen is the same as on Dashboard screen.

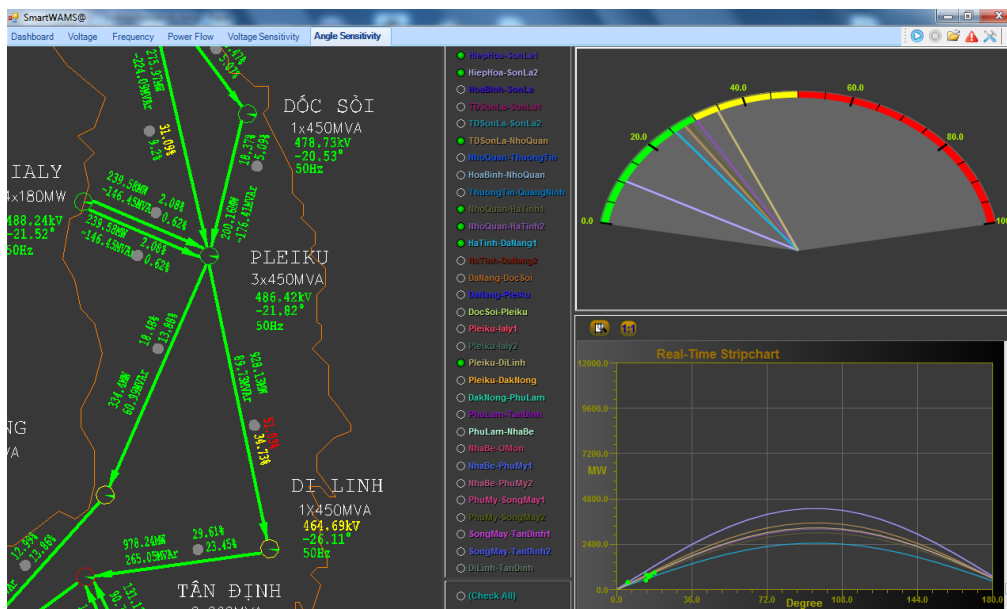

Figure 11. Angle Sensitivity Screen

4.7. Alarm

On Alarm screen, operators can observe (Figure 12):

- ◆ List of warnings of each operational parameter at the observation node and transmission line;
- ◆ Present and historical state of system;
- ◆ Selectable warnings on demand.

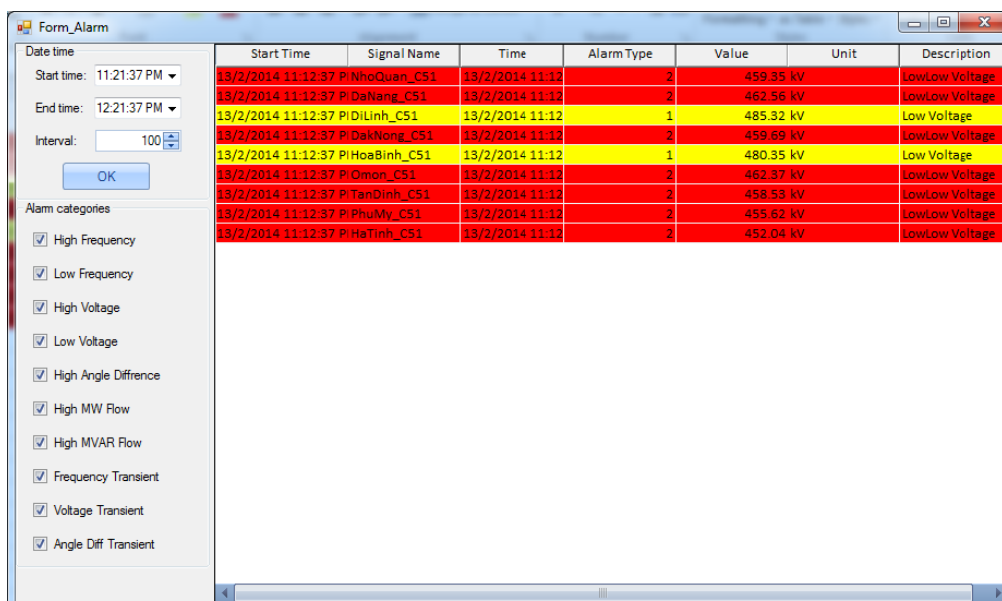

Figure 12. Alarm Screen

Head Office

Suite #604 - VNA8 Building,
8 Tran Hung Dao Str., Hanoi, Vietnam
T. +84-24-3825 1072
F. +84-24-3825 8037
W. www.ats.com.vn
E. ecommerce@ats.com.vn

Factory

Lot No. A2CN6,
Tu Liem Industrial Zone,
Hanoi, Vietnam
T. +84-24-3780 5053
F. +84-24-3780 5060

HCMC Office

13-15 Nguyen The Loc Street
Ho Chi Minh City, Vietnam
T. +84-28-3948 3548
F. +84-28-3948 3549

